

# IC Housing for LED lamps & MR16 (Halogen) 3-1/2" and 4" (GU10/MR16/PAR20)

OR INSTALLATION IN A CEILING WITH INSULATION  
SUITABLE FOR DAMP LOCATION / WET WITH SHOWER TRIM

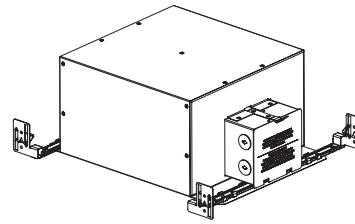

**NOTICE**  
After the recessed luminaire is installed, access to wiring compartment and splices is accomplished from the room-side by removing the can.

NOTE: Provided compliance with cl. 16.32 is realized.

## “IC” Type and Air Tight

IC35GU10-10W, IC35MR16-120-10W, IC35MR16-277-10W,  
IC40GU10-10W, IC40MR16-120-10W, IC40MR16-277-10W,  
IC40PAR-10W

## “IC” Type and NON Air Tight

IC35MR16-120-37W, IC35MR16-120D-37W, IC35MR16-277-37W,  
IC35MR16-277D-37W, IC40MR16-120-37W, IC40MR16-120D-37W,  
IC40MR16-277-37W, IC40MR16-277D-37W

### 1. SHUT OFF ELECTRICAL SUPPLY AT SOURCE.

2. Locate position of mounting frame and install before the ceiling material board. Fasten the mounting frame to the wood joists (or other ceiling type) with the adjustable mounting bars (10" to 24.5"). To shorten the bars to 10", remove bars and cut off at the notch (See adjustable mounting bars detail view).

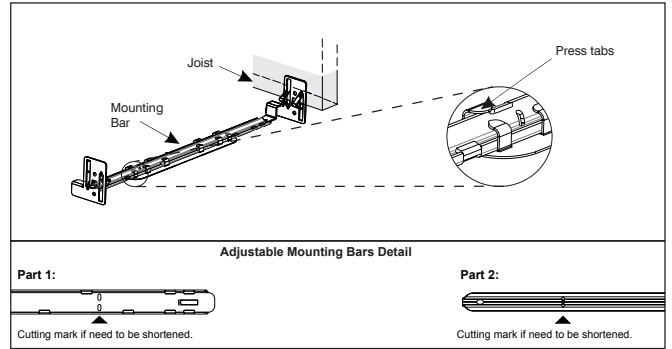

3. Once the correct bar length is known, fold down and press tabs to lock the plate to the mounting bars.

4. Bring the electrical wiring to the housing junction box as per applicable local electrical codes. Open the junction box and connect the wires based on the diagrams below. Close the junction box.

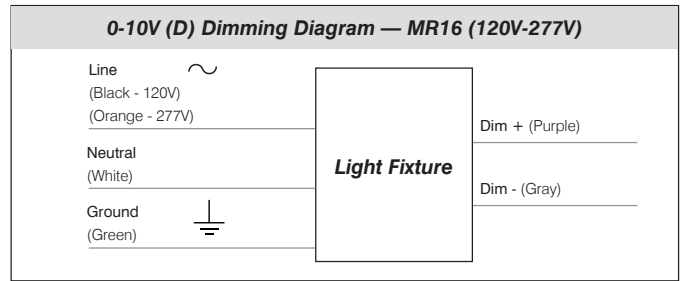
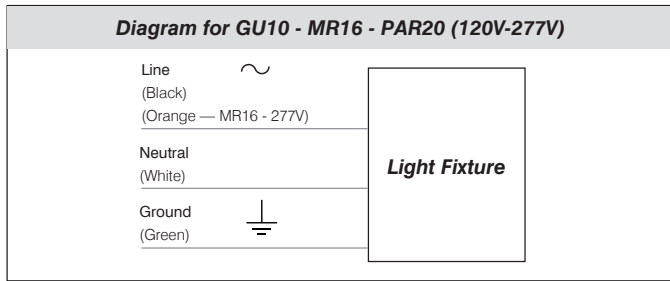

5. Unlock the upper part of the can's captive hooks in order to release them.

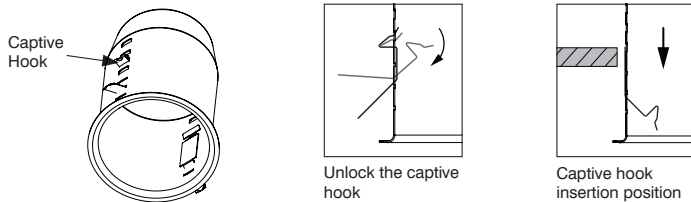

6. Install the ceiling material and locate the center of each fixture on the ceiling material.

7. Cut a hole to a diameter of:  
3-1/2" Series:  $\varnothing$  3-5/8" (92 mm)      4" Series:  $\varnothing$  4-1/4" (108 mm)

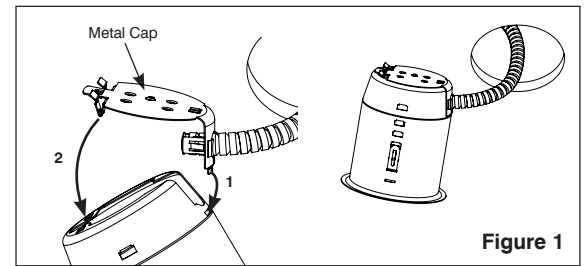

8. Attach the metal cap to the can, make sure it clicks into place. (see figure 1)

9. Paste the membrane to the metal cap and make sure it is watertight (**except 37W**). (see figure 2)

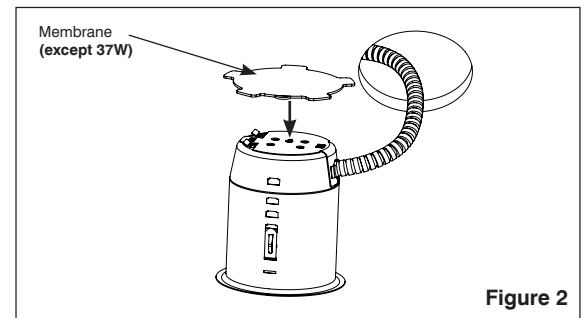

10. Use the various adjustment holes on each side of the can and adjust the position of the captive hooks according to the ceiling thickness.

**Note:** Captive hooks are preinstalled for 1-3/8" (35 mm) ceiling thickness. Adjustment possibility up to a maximum of 2" (51 mm) ceiling thickness.

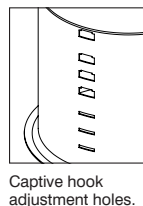
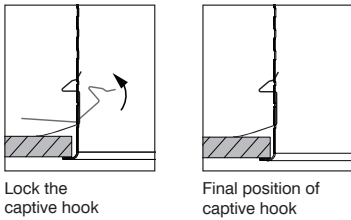

Figure 2

- Lock the captive hooks and make sure the hooks apply a pressure against the ceiling to maintain the can firmly in place.



Lock the captive hook

Final position of captive hook

**INSTALLATION OF ALUMINUM TAPE (EXCEPT 37W HOUSING)**

- Remove the film on the back of the included aluminum tape.
- Apply the aluminum tape on both sides of the can in order to cover the hooks opening.
- For lamps GU10, MR16 and PAR20 fixed model, follow these steps.

- Insert: a) the lamp into the socket  
 b) the lamp into the trim  
 c) the trim into the housing

For lamps PAR20 adjustable model, start by removing the socket.

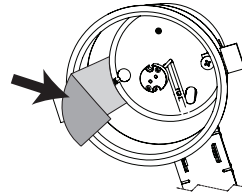

**GU10**

**MR16**

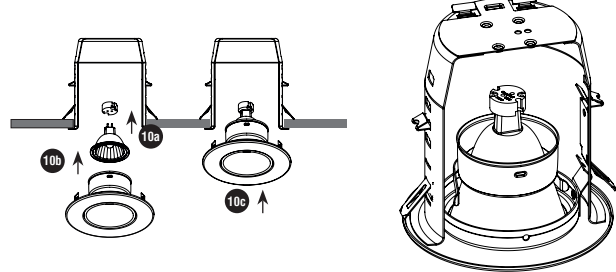
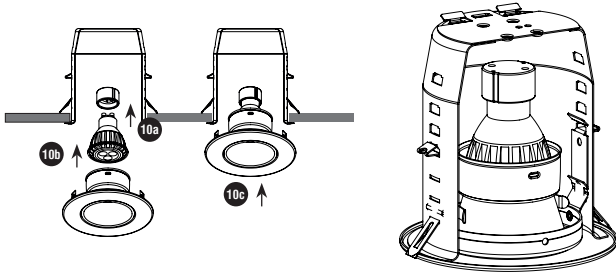

**PAR20 (fixed model)**

**PAR20 (adjustable model)**

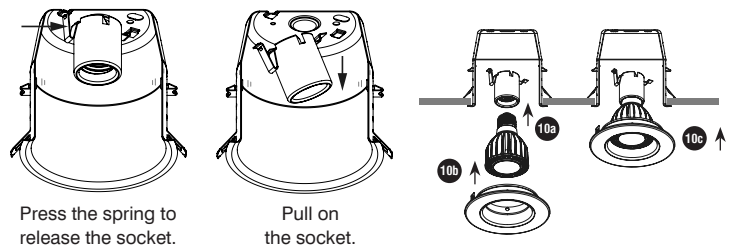
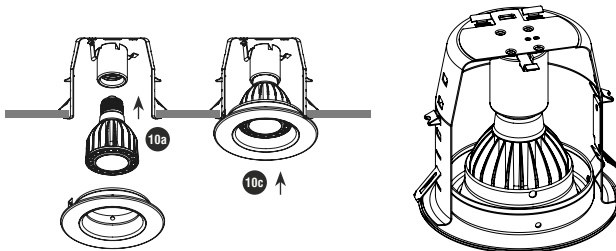

Please keep these instructions for maintenance reference.

**WARNING**  
 The use of other company's (non-Contraste) products or components (e. g. trims) in conjunction with Contrast Lighting M.L. Inc. products may not be covered by UL approvals and could be hazardous. Such use automatically voids all Contrast Lighting M.L. Inc. warranty and responsibility of these products.

**WARNING: RISK OF FIRE**  
 Most dwellings built before 1985 have supply wires rated 60° C. Consult a qualified electrician before installing.



**WARRANTY:** CONTRAST LIGHTING M. L. INC. guarantees the components against manufacturing defects for a period of one (1) year, under normal use with proof of purchase. The obligation of the manufacturer consists in the cost of the components and does not cover the cost of labor and transport for replacement. For all claims, please contact your local supplier. See our Web site for additional warranty details.

**CONTRASTE**

1009, rue du Parc Industriel  
 Lévis (Québec) G6Z 1C5 Canada

Tel.: 1-888-839-4624  
 Fax.: 1-877-839-7057

contrastlighting.com  
 info@contrastlighting.com

© 2020 Contrast Lighting M.L. Inc.  
 All rights reserved

EC719  
 104936