

SPECIFICATION SHEET

Ardito LED - A3SWW

3-1/2" Series**Ultra-Thin Profile Square Wall Wash Trim**

Project _____

Notes _____

Fixture Type _____

Date _____

**WITH FLANGE**

A3SWW-2222 - XXX (illustrated)

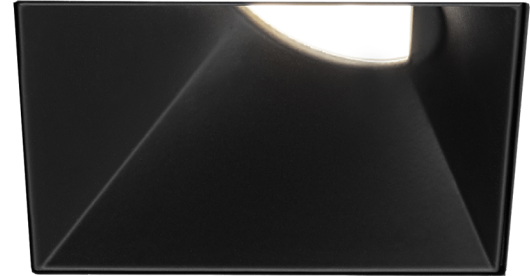
**FLANGELESS TRIM**

A3SWW-TR22 - XXX (illustrated)

Aluminum Square, 3-1/2" high efficiency wall wash dimmable LED. May be installed with a low profile ultra-thin flange or flangeless trim in configuration for insulated, non-insulated and remodel (non-IC) ceilings.



SPECIFICATIONS

TRIM DETAILS	<p>Requires a 6-1/2" (165 mm) clearance beyond the ceiling level for standard using and 7" (178 mm) for Lumenetix option using.</p> <p>Perfect fit into ceiling</p> <p>Each part of the housing should be at LEAST 3" (76 mm) from insulation (non-IC configurations)</p> <p>Can fit in ceilings up to 1-1/2" (38 mm) thick</p> <p>Junction box is accessible from below the ceiling for ease of maintenance</p>
HEAT SINK	High quality injection molded aluminum heat sink ensuring maximum heat dissipation for optimal performance.
CEILING CUTOUT	<p>3-3/4" (95 mm) x 3-3/4" (95 mm)</p> <p>Included: Cardboard cutout template</p> <p>Optional: Reusable steel cutout template for square trim (TEMP-SQ)</p>
CERTIFICATION	<ul style="list-style-type: none"> cULus E343977 for damp locations Certified Air Tight ASTM E283
WARRANTY	<p>1 year on components against manufacturing defects</p> <p>5 years on LED arrays and drivers</p>

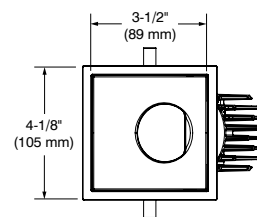
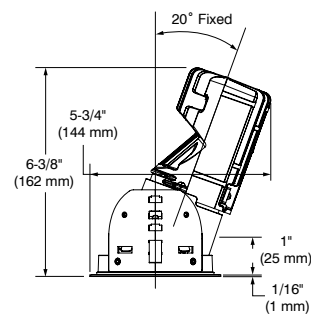
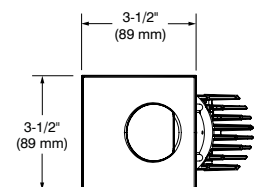
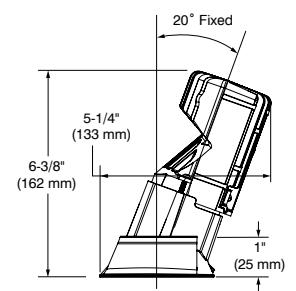
WITH FLANGE**FLANGELESS TRIM**

CONTRASTE

2020-09
Revision 2

PRINTED IN CANADA

1009, rue du Parc Industriel
Lévis (Québec) G6Z 1C5 Canada
Tel.: 1-888-839-4624
Fax.: 1-877-839-7057
contrastlighting.com
info@contrastlighting.com

© 2020 Contrast Lighting M.L. Inc.
All rights reserved

Contrast Lighting M.L. Inc. reserves the right to make changes in specifications and/or to discontinue any product at any time without notice or obligation and will not be liable for any consequences resulting from the use of this publication.

SPECIFICATION SHEET

Ardito LED - A3SWW

3-1/2" Series

Ultra-Thin Profile Square Wall Wash Trim

SPECIFICATIONS (CONT'D)

COMPATIBLE HOUSINGS

	Remodel Housing	New Construction Housing	Insulated Housing	Insulated Air Tight Housing (Title 24)	Ceiling thickness suggested for insulated housing as a using standard and Lumenetix option
Performance 1 (14W)	REA3V1	NWA3SV1	*ISA3SV1	*ICAT6S3-ARV1	* Ceiling thickness must be at least 1/2" (13 mm) for insulated housing as a using standard.
Performance 2 (23W)	REA3V2	NWA3SV2	*ISA3SV2	*ICAT6S3-ARV2	
Lumenetix (12.5W)	REA3VL	NWA3SVL	**ISA3SVL		** Ceiling thickness must be at least 1" (25 mm) for insulated housing with Lumenetix option.

For dimming, please visit our Web site frequently to find our suggested compatible dimmers: www.contrastlighting.com

OPTIC SYSTEM

Choice of available lense:**Frosted/Frosted (F)****Standard**

Flood (L)	54°
-----------	-----

* Average beam shown. Consult .ies files on our Website for more details.

FLANGE FINISHES

Options in red may generate a longer production lead time

Powder coat painted or plated die formed steel.

Different finishes available:

24K Gold Plated (-03), Chrome (-04), Brushed Chrome (-04BR), Matte White (-11), Brushed Nickel (-12BR), Satin Nickel (-13), Matte Black (-22) and Polar Grey (-25)

REFLECTOR FINISHES

Painted

Matte White (11)
*Matte black (22)

Natural Anodized Aluminum (AN)

* **Recommended for optimum Wall Wash result**

FLANGELESS TRIMS

Perforated aluminum plate for borderless product, allowing you to plaster up to the edge of the opening of the Ardito luminaire.

Mud-in-plate sold separately.

Ordering code: MIPA3S

Consult housing specification sheet for more details.

CONTRASTE2020-09
Revision 2

PRINTED IN CANADA

1009, rue du Parc Industriel
Lévis (Québec) G6Z 1C5 Canada
Tel.: 1-888-839-4624
Fax.: 1-877-839-7057
contrastlighting.com
info@contrastlighting.com

© 2020 Contrast Lighting M.L. Inc.
All rights reserved

Contrast Lighting M.L. Inc. reserves the right to make changes in specifications and/or to discontinue any product at any time without notice or obligation and will not be liable for any consequences resulting from the use of this publication.

Ardito LED - A3SWW

3-1/2" Series

Ultra-Thin Profile Square Wall Wash Trim



TRIM WITH FLANGE CODIFICATION EXAMPLE

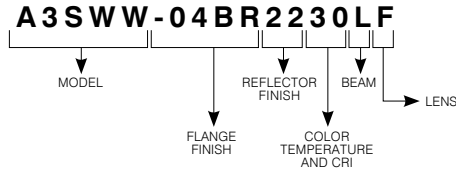

Options in red may generate a longer production lead time.

TRIM WITH FLANGE ORDERING CODES **A3SWW**

MODEL	FLANGE FINISHES	REFLECTOR FINISHES	COLOR TEMPERATURES AND CRI	BEAM	LENS
A3SWW				L	F
A3SWW	-04BR Brushed Chrome	PAINTED	27 2,700K (90+ CRI)	L Flood (54°)	F Frosted/Frosted
	-11 Matte White	11 Matte White	30 3,000K (90+ CRI)		
	-12BR Brushed Nickel	22* Matte Black	35 3,500K (90+ CRI)		
	-22 Matte Black	AN Natural Anodized Aluminum	40 4,000K (90+ CRI)		
	-25 Polar Grey		CT 1,650K to 4,000K (90+ CRI)		
	-03 24K Gold Plated	<i>*(Recommended for optimum Wall Wash results)</i>	WD 3,050K to 1,800K (90+ CRI)		
	-04 Chrome				
	-13 Satin Nickel				

FLANGELESS TRIM CODIFICATION EXAMPLE

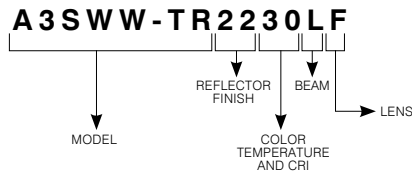

Mud-in-plate required for use of flangeless trim (see ordering code below)

Options in red may generate a longer production lead time.

FLANGELESS TRIM ORDERING CODES **A3SWW-TR**

MODEL	REFLECTOR FINISHES	COLOR TEMPERATURES AND CRI	BEAM	LENS
A3SWW-TR			L	F
A3SWW-TR	PAINTED	27 2,700K (90+ CRI)	L Flood (54°)	F Frosted/Frosted
	11 Matte White	30 3,000K (90+ CRI)		
	22* Matte Black	35 3,500K (90+ CRI)		
	AN Natural Anodized Aluminum	40 4,000K (90+ CRI)		
		CT 1,650K to 4,000K (90+ CRI)		
	<i>*(Recommended for optimum Wall Wash results)</i>	WD 3,050K to 1,800K (90+ CRI)		

SPECIFICATION SHEET

Ardito LED - A3SWW

3-1/2" Series

Ultra-Thin Profile Square Wall Wash Trim



MUD-IN-PLATE

Required with the use of flangeless trims.
Consult housing specification sheet for more details.



Code: MIPA3S

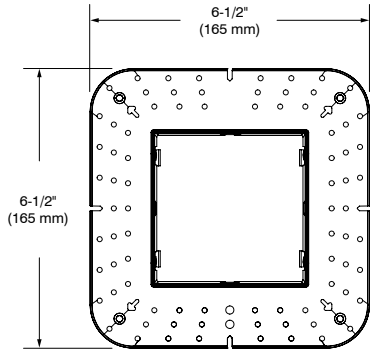

REUSABLE TEMPLATE OPTION

Reusable steel cutout template for square trim.

Code: TEMP-SQ

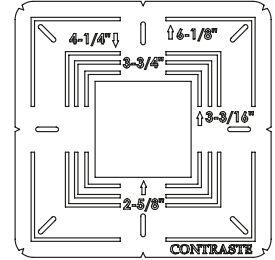

ORDERING CODES for replacement lenses

Frosted/ Frosted (F): **317285**

Ardito LED - A3SWW

3-1/2" Series**Ultra-Thin Profile Square Wall Wash Trim**

PHOTOMETRIC DATA



In order to obtain the accurate photometric data, multiply the lumens relative to your product selection by the applicable factor(s). Take note these factors also need to be implemented in the .ies files available on our website.

WITH PERFORMANCE 1 HOUSING (14W)

	Flood (54°)	
2,700K with 90+ CRI	455 lm	32.5 lm/W
3,000K with 90+ CRI	471 lm	33.6 lm/W
3,500K with 90+ CRI	493 lm	35.2 lm/W
4,000K with 90+ CRI	506 lm	36.1 lm/W

WITH PERFORMANCE 2 HOUSING (23W)

	Flood (54°)	
2,700K with 90+ CRI	648 lm	28.2 lm/W
3,000K with 90+ CRI	671 lm	29.2 lm/W
3,500K with 90+ CRI	701 lm	30.5 lm/W
4,000K with 90+ CRI	719 lm	31.3 lm/W

WITH PERFORMANCE L HOUSING (12.5W)

	Flood (54°)	
Warm Dimming (WD) with 90+ CRI	234 lm	18.7 lm/W
Color Tuning (CT) with 90+ CRI	245 lm	19.6 lm/W

CONTRASTE

2020-09
Revision 2

PRINTED IN CANADA

1009, rue du Parc Industriel
Lévis (Québec) G6Z 1C5 Canada
Tel.: 1-888-839-4624
Fax.: 1-877-839-7057
contrastlighting.com
info@contrastlighting.com

© 2020 Contrast Lighting M.L. Inc.
All rights reserved

Contrast Lighting M.L. Inc. reserves the right to make changes in specifications and/or to discontinue any product at any time without notice or obligation and will not be liable for any consequences resulting from the use of this publication.

Ardito LED - A3SWW

3-1/2" Series

Ultra-Thin Profile Square Wall Wash Trim

PHOTOMETRIC DATA



3,000K, 90+ CRI, Flood, Performance 1

CANDLEPOWER DISTRIBUTION

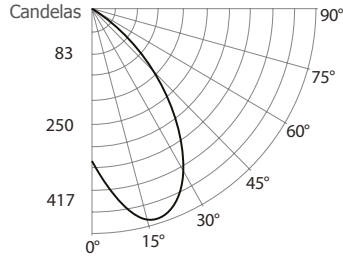

LIGHT CONE

Distance	FC	DIA
04'	21.5	4.0'
08'	5.4	8.1'
12'	2.4	12.1'
16'	1.3	16.2'

Beam: 54°
Beam Edge defined as 50% of Maximum Nadir Candle-power.

LUMINAIRE

Performance 1 LED	3,000K Flood	
CBCP / Lumens	343	/ 442.8
Watts	120V	277V
	14W	14.5W
Operating AMPS	0.12A	0,052A
Lumen Maintenance	L70 @ 50,000 Hrs	
CRI	90+	
Lumens/Watt	31.6	
Spacing Criteria	0,91	

COEFFICIENT OF UTILIZATION - %

Ceiling Reflect %	80		50		30		
Wall Reflect %	50	30	50	30	50	30	
RCR	0	112	112	105	105	100	100
	2	94	90	89	86	86	84
	4	79	73	76	71	74	70
	6	67	61	65	59	63	59
	8	58	51	56	51	55	50
	10	50	44	49	44	48	43

Zonal Cavity Method
Effective Floor Cavity Reflectance 20%

ZONAL LUMEN SUMMARY

ZONE	LUMENS	%LUMINAIRE
0-30	230.1	52%
0-40	333.2	75.2%
0-60	434.8	98.2%
60-90	8.0	1.8%
0-180	442.8	100%

CANDELAS DISTRIBUTION

DEGREES/ VERTICAL	CANDELAS	DEGREES/ VERTICAL	CANDELAS
0	343	40	278
5	404	50	125
10	458	60	46
15	487	70	3
20	486	80	0
25	461	90	0
30	413		

Footcandles On Wall - Performance 1

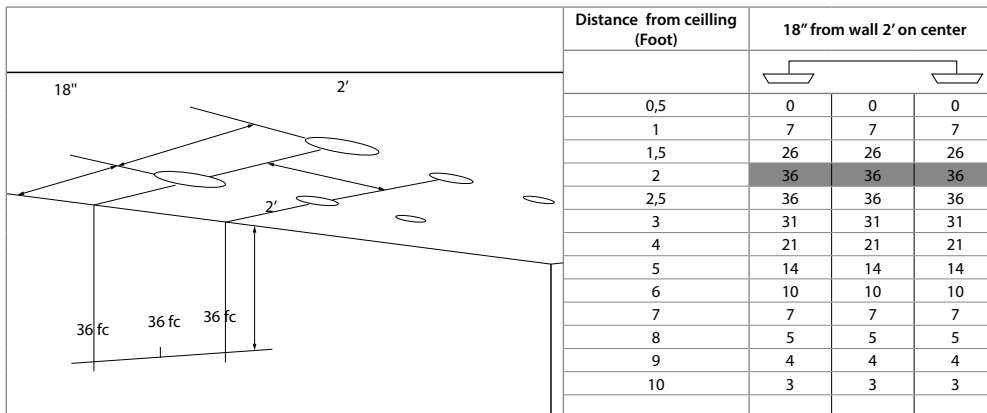

Note: Footcandles Data

Ardito LED - A3SWW

3-1/2" Series

Ultra-Thin Profile Square Wall Wash Trim

PHOTOMETRIC DATA



3,000K, 90+ CRI, Flood, Performance 2

CANDLEPOWER DISTRIBUTION

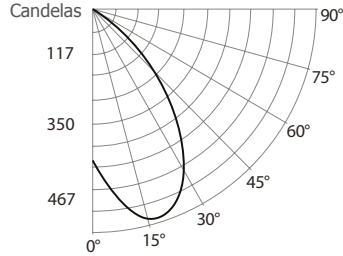

LIGHT CONE

Distance	FC	DIA
04'	29.4	4.10'
08'	7.4	8.2'
12'	3.3	12.3'
16'	1.8	16.3'

Beam: 54°
Beam Edge defined as 50% of Maximum Nadir Candle-power.

LUMINAIRE

Performance 2 LED	3,000K Flood	
CBCP / Lumens	471	/ 629.9
Watts	120V	277V
	23W	23,5W
Operating AMPS	0.19A	0.085A
Lumen Maintenance	L70 @ 50,000 Hrs	
CRI	90+	
Lumens/Watt	27.4	
Spacing Criteria	0.91	

COEFFICIENT OF UTILIZATION - %

Ceiling Reflect %	80		50		30		
Wall Reflect %	50	30	50	30	50	30	
RCR	0	112	112	104	104	100	100
	2	94	89	89	86	86	83
	4	79	72	75	70	73	69
	6	67	60	64	59	63	58
	8	57	51	55	50	54	49
	10	50	44	49	43	48	43

Zonal Cavity Method
Effective Floor Cavity Reflectance 20%

ZONAL LUMEN SUMMARY

ZONE	LUMENS	%LUMINAIRE
0-30	319.9	50.8%
0-40	468	74.3%
0-60	618.1	98.1%
60-90	11.8	1.9%
0-90	629.9	100%

CANDELAS DISTRIBUTION

DEGREES/ VERTICAL	CANDELAS	DEGREES/ VERTICAL	CANDELAS
0	471	40	398
5	555	50	188
10	633	60	68
15	679	70	3
20	683	80	0
25	651	90	0
30	584		

Footcandles On Wall - Performance 2

Distance from ceiling (foot)	18" from wall 2' on center		
0,5	0	0	0
1	11	11	11
1,5	38	38	38
2	53	53	53
2,5	51	51	51
3	44	44	44
4	29	29	29
5	19	19	19
6	13	13	13
7	10	10	10
8	7	7	7
9	6	6	6
10	5	5	5

Note: Footcandles Data