

SPECIFICATION SHEET

Ardito LED - A4SFR

4" Series

Ultra-Thin Profile Square Regressed Trim

Project _____

Notes _____

Fixture Type _____

Date _____



WITH FLANGE

A4SFR-11AN - XXX (illustrated)

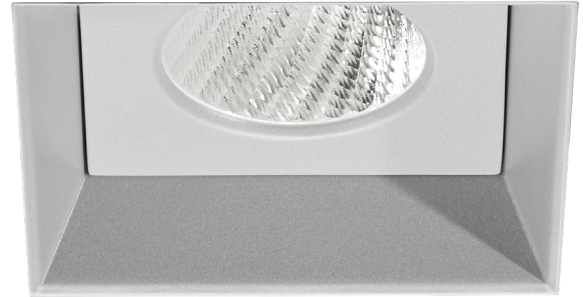

FLANGELESS TRIM

A4SFR-TRAN - XXX (illustrated)

Aluminum square, 4" high efficiency regressed dimmable LED downlight trim. May be installed with a low profile ultra-thin flange or flangeless trim in configuration for insulated, non-insulated and remodel (non-IC) ceilings.



SPECIFICATIONS

TRIM DETAILS	<p>Requires a 6-1/2" (165 mm) clearance beyond the ceiling level for standard using and 7" (178 mm) for Lumenetix option using.</p> <p>Perfect fit into ceiling</p> <p>Each part of the housing should be at LEAST 3" (76 mm) from insulation (non-IC configurations)</p> <p>Can fit in ceilings up to 1-1/2" (38 mm) thick</p> <p>Junction box is accessible from below the ceiling for ease of maintenance</p>
HEAT SINK	<p>High quality injection molded aluminum heat sink ensuring maximum heat dissipation for optimal performance.</p>
CEILING CUTOUT	<p>4-1/4" (108 mm) x 4-1/4" (108 mm)</p> <p>Included: Cardboard cutout template</p> <p>Optional: Reusable steel cutout template for square trim (TEMP-SQ)</p>
CERTIFICATION	<ul style="list-style-type: none"> cULus E343977 for damp locations Certified under California Energy Commission according to reference joint Appendix 8 (JA8-2016) Certified Air Tight ASTM E283
WARRANTY	<p>1 year on components against manufacturing defects</p> <p>5 years on LED arrays and drivers</p>

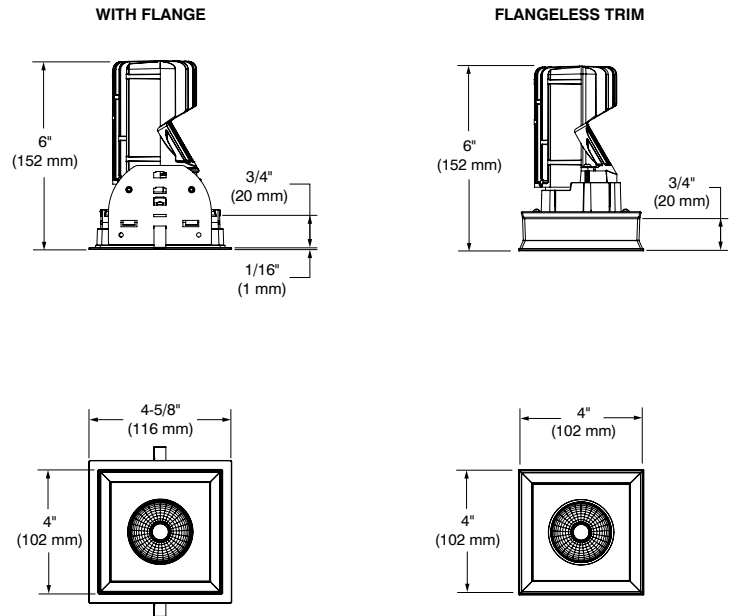

SPECIFICATION SHEET

Ardito LED - A4SFR**4" Series****Ultra-Thin Profile Square Regressed Trim**

SPECIFICATIONS (CONT'D)

COMPATIBLE HOUSINGS

	Remodel Housing	New Construction Housing	Insulated Housing	Insulated Air Tight Housing (Title 24)	IC AIR TIGHT 8200 (max=125)	Ceiling thickness suggested for insulated housing as a using standard and Lumenetix option
Performance 1 (14W)	REA4V1	NWA4SV1	*ISA4SV1	*ICAT6S4-ARV1	JA8 LISTED	* Ceiling thickness must be at least 1/4" (6.4 mm) for insulated housing as a using standard.
Performance 2 (23W)	REA4V2	NWA4SV2	*ISA4SV2	*ICAT6S4-ARV2	JA8 LISTED	
Lumenetix (12.5W)	REA4VL	NWA4SVL	**ISA4SVL			** Ceiling thickness must be at least 3/4" (19 mm) for insulated housing with Lumenetix option.

For dimming, please visit our Web site frequently to find our suggested compatible dimmers: www.contrastlighting.com

OPTIC SYSTEM

Interchangeable optional optical reflectors and lenses available to customize your lighting.

Choice of available lenses:

Stackable (up to 2) (also sold separately)

Clear (C)

Frosted (F)

Honeycomb (H): the honeycomb louver reduces glare

Linear (L): the linear lens directs the lamp beam to create a strip of light

Prismatic (P): the prismatic lens diffuses and spreads the light in an even overall pattern

Solite (S): the solite lens softens the light in an even overall pattern

Optical reflectors available: Spot, Narrow Flood, Flood

	Standard	Lumenetix
Spot (S)	15°	Not available
Narrow Flood (M)	32°	33°
Flood (L)	40°	44°

* Average beams shown. Consult .ies files on our Website for more details.

FLANGE FINISHES

Powder coat painted or plated die formed steel.

Options in red may generate a longer production lead time

Different finishes available:

24K Gold Plated (-03), Chrome (-04), Brushed Chrome (-04BR), Matte White (-11), Brushed Nickel (-12BR), Satin Nickel (-13), Matte Black (-22) and Polar Grey (-25)

REFLECTOR FINISHES

Painted

Matte White (11)

Matte black (22)

Natural Anodized Aluminum (AN)

Black (BK)

FLANGELESS TRIMS (OPTION)

Perforated aluminum plate for flangeless product, allowing you to plaster up to the edge of the opening of the Ardito luminaire.

Mud-in-plate sold separately.

Ordering code: MIPA4S

Consult housing specification sheet for more details.

CONTRASTE2020-09
Revision 2

PRINTED IN CANADA

1009, rue du Parc Industriel
Lévis (Québec) G6Z 1C5 Canada
Tel.: 1-888-839-4624
Fax.: 1-877-839-7057
contrastlighting.com
info@contrastlighting.com

© 2020 Contrast Lighting M.L. Inc.
All rights reserved

Contrast Lighting M.L. Inc. reserves the right to make changes in specifications and/or to discontinue any product at any time without notice or obligation and will not be liable for any consequences resulting from the use of this publication.

SPECIFICATION SHEET

Ardito LED - A4SFR

4" Series

Ultra-Thin Profile Square Regressed Trim



TRIM WITH FLANGE CODIFICATION EXAMPLE

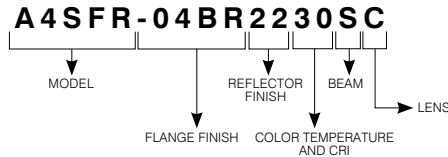

Options in red may generate a longer production lead time.

TRIM WITH FLANGE ORDERING CODES **A4SFR**

MODEL	FLANGE FINISHES	REFLECTOR FINISHES	COLOR TEMPERATURES AND CRI	BEAMS	LENSES
A4SFR					
A4SFR	-04BR Brushed Chrome	PAINTED	27 2,700K (90+ CRI)	S Spot (15°) <i>(not available with CT and WD)</i> M Narrow Flood (32°) <i>CT and WD (33°)</i> L Flood (40°) <i>CT and WD (44°)</i>	C Clear F Frosted H Honeycomb L Linear P Prismatic S Solite
	-11 Matte White	11 Matte White	30 3,000K (90+ CRI)		
	-12BR Brushed Nickel	22 Matte Black	35 3,500K (90+ CRI)		
	-22 Matte Black	AN Natural Anodized Aluminum	40 4,000K (90+ CRI)		
	-25 Polar Grey	BK Black	CT 1,650K to 4,000K (90+ CRI)		
	-03 24K Gold Plated		WD 3,050K to 1,800K (90+ CRI)		
	-04 Chrome				
	-13 Satin Nickel				

FLANGELESS TRIM OPTION — CODIFICATION EXAMPLE

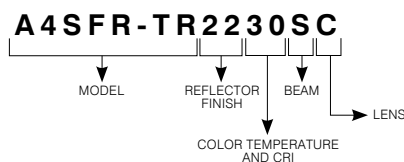

Mud-in-plate required for use of flangeless trim (see ordering code on next page)

Options in red may generate a longer production lead time.

FLANGELESS TRIM OPTION — ORDERING CODES **A4SFR-TR**

MODEL	REFLECTOR FINISHES	COLOR TEMPERATURES AND CRI	BEAMS	LENSES
A4SFR-TR				
A4SFR-TR	PAINTED	27 2,700K (90+ CRI)	S Spot (15°) <i>(not available with CT and WD)</i> M Narrow Flood (32°) <i>CT and WD (33°)</i> L Flood (40°) <i>CT and WD (44°)</i>	C Clear F Frosted H Honeycomb L Linear P Prismatic S Solite
	11 Matte White	30 3,000K (90+ CRI)		
	22 Matte Black	35 3,500K (90+ CRI)		
	AN Natural Anodized Aluminum	40 4,000K (90+ CRI)		
	BK Black	CT 1,650K to 4,000K (90+ CRI)		
		WD 3,050K to 1,800K (90+ CRI)		

CONTRASTE

SPECIFICATION SHEET

Ardito LED - A4SFR

4" Series

Ultra-Thin Profile Square Regressed Trim



MUD-IN-PLATE

Required with the use of flangeless trims.
Consult housing specification sheet for more details.



4-1/4" (108 mm) x 4-1/4" (108 mm)

Code: MIPA4S

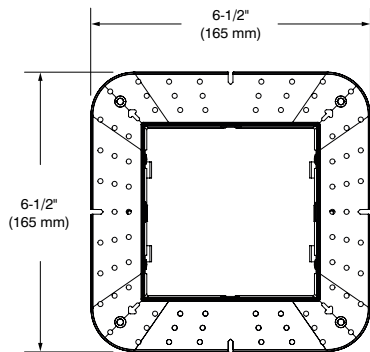

REUSABLE TEMPLATE OPTION

Reusable steel cutout template
for square trim.

Code: TEMP-SQ

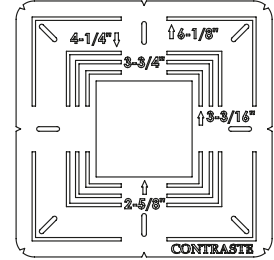

ORDERING CODES

for replacement lenses and reflectors

For future on-site modifications of the light distribution.

Lenses (to modify light diffusion)

Stackable (up to 2)

Clear (C): **104036**Frosted (F): **317240**Linear (L): **104037**Solite (S): **104038**Prismatic (P): **104039**Honeycomb (H): **104040**

Reflectors (to modify the beam angle)

For a Spot: **103942**For a Narrow Flood: **103912**For a Flood: **103943**

CONTRASTE

2020-09
Revision 2

PRINTED IN CANADA

1009, rue du Parc Industriel
Lévis (Québec) G6Z 1C5 Canada
Tel.: 1-888-839-4624
Fax.: 1-877-839-7057
contrastlighting.com
info@contrastlighting.com

© 2020 Contrast Lighting M.L. Inc.
All rights reserved

Contrast Lighting M.L. Inc. reserves the right to make changes in specifications and/or to discontinue any product at any time without notice or obligation and will not be liable for any consequences resulting from the use of this publication.

Ardito LED - A4SFR

4" Series**Ultra-Thin Profile Square Regressed Trim**

PHOTOMETRIC DATA



In order to obtain the accurate photometric data, multiply the lumens relative to your product selection by the applicable factor(s). Take note these factors also need to be implemented in the .ies files available on our website.

WITH PERFORMANCE 1 HOUSING (14W)

	Spot (15°)		Narrow Flood (32°)		Flood (40°)	
	lm	lm/W	lm	lm/W	lm	lm/W
2,700K with 90+ CRI	1,309	93.5	1,249	89.2	1,214	86.7
3,000K with 90+ CRI	1,356	96.9	1,294	92.4	1,258	89.9
3,500K with 90+ CRI	1,422	101.6	1,356	96.9	1,319	94.2
4,000K with 90+ CRI	1,458	104.1	1,391	99.4	1,353	96.6

WITH PERFORMANCE 2 HOUSING (23W)

	Spot (15°)		Narrow Flood (32°)		Flood (40°)	
	lm	lm/W	lm	lm/W	lm	lm/W
2,700K with 90+ CRI	1,856	80.7	1,804	78.4	1,812	78.8
3,000K with 90+ CRI	1,923	83.6	1,869	81.3	1,878	81.7
3,500K with 90+ CRI	2,016	87.7	1,960	85.2	1,969	85.6
4,000K with 90+ CRI	2,068	89.9	2,010	87.4	2,019	87.8

WITH PERFORMANCE L HOUSING (12.5W)

	Narrow Flood (33°)		Flood (44°)	
	lm	lm/W	lm	lm/W
Warm Dimming (WD) with 90+ CRI	668	53.4	649	51.9
Color Tuning (CT) with 90+ CRI	700	56	680	54.4

Lens Factors	
C	1
F	0.71
H	0.57

CONTRASTE

2020-09
Revision 2

PRINTED IN CANADA

1009, rue du Parc Industriel
Lévis (Québec) G6Z 1C5 Canada
Tel.: 1-888-839-4624
Fax.: 1-877-839-7057
contrastlighting.com
info@contrastlighting.com

© 2020 Contrast Lighting M.L. Inc.
All rights reserved

Contrast Lighting M.L. Inc. reserves the right to make changes in specifications and/or to discontinue any product at any time without notice or obligation and will not be liable for any consequences resulting from the use of this publication.

Ardito LED - A4SFR

4" Series

Ultra-Thin Profile Square Regressed Trim

PHOTOMETRIC DATA



3,000K, 90+ CRI, Spot, Performance 1

CANDLEPOWER DISTRIBUTION

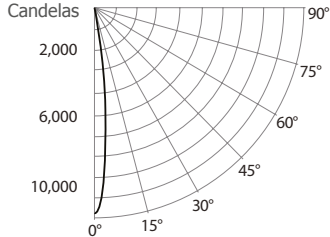

LIGHT CONE

Distance	FC	DIA
06'	326.5	1.6'
08'	183.6	2.1'
10'	117.5	2.6'
12'	81.6	3.2'
14'	59.9	3.7'
16'	45.9	4.2'

Beam: 15°
Beam Edge defined as 50% of Maximum Nadir Candle-power.

LUMINAIRE

Performance 1 LED	3,000K	Spot
CBCP / Lumens	11,753	1,356.2
Watts	120V	277V
	14W	14.5W
Operating AMPS	0.12A	0.052A
Lumen Maintenance	L70 @ 50,000 Hrs	
CRI	90+	
Lumens/Watt	96.9	
Spacing Criteria	0.26	

COEFFICIENT OF UTILIZATION - %

Ceiling Reflect %	80			50			30			
Wall Reflect %	50	30	50	30	50	30	50	30	50	30
RCR	0	119	119	111	111	106	106	106	106	106
	2	109	106	104	102	101	99	99	99	99
	4	101	97	98	95	96	94	94	94	94
	6	95	91	93	90	92	89	89	89	89
	8	90	86	89	86	88	85	85	85	85
	10	86	82	85	82	84	81	81	81	81

Zonal Cavity Method
Effective Floor Cavity Reflectance 20%

ZONAL LUMEN SUMMARY

ZONE	LUMENS	%LUMINAIRE
0-30	1,327.6	97.9%
0-40	1,356.1	100%
0-60	1,356.2	100%
60-90	0.0	0%
0-90	1,356.2	100%

MULTIPLE UNIT DATA - (RCR 2)

SPACING ON CENTER	INITIAL FOOTCANDLES	WATTS/ SQ. FT.
5'	69	0.59
6'	39	0.33
7'	27	0.23
8'	27	0.23
9'	17	0.15

38' x 38' x 10' Room. Workplan located 2-1/2' (30").
Reflectance factor 80%/50%/30%

CANDELAS DISTRIBUTION

DEGREES/ VERTICAL	CANDELAS	DEGREES/ VERTICAL	CANDELAS
0	11,753	40	0
5	8,353	50	0
10	3,936	60	0
15	1,524	70	0
20	836	80	0
25	490	90	0
30	204		

3,000K, 90+ CRI, Narrow Flood, Performance 1

CANDLEPOWER DISTRIBUTION

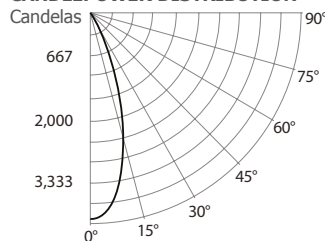

LIGHT CONE

Distance	FC	DIA
06'	109.4	3.4'
08'	61.6	4.6'
10'	39.4	5.7'
12'	27.4	6.9'
14'	20.1	8.0'
16'	15.4	9.2'

Beam: 32°
Beam Edge defined as 50% of Maximum Nadir Candle-power.

LUMINAIRE

Performance 1 LED	3,000K	Narrow Flood
CBCP / Lumens	3,940	1,294.3
Watts	120V	277V
	14W	14.5W
Operating AMPS	0.12A	0.052A
Lumen Maintenance	L70 @ 50,000 Hrs	
CRI	90+	
Lumens/Watt	92.5	
Spacing Criteria	0.55	

COEFFICIENT OF UTILIZATION - %

Ceiling Reflect %	80			50			30			
Wall Reflect %	50	30	50	30	50	30	50	30	50	30
RCR	0	119	119	111	111	106	106	106	106	106
	2	107	104	102	100	99	97	97	97	97
	4	97	93	94	91	93	90	90	90	90
	6	90	85	88	84	86	83	83	83	83
	8	83	79	82	78	81	78	78	78	78
	10	78	73	77	73	76	72	72	72	72

Zonal Cavity Method
Effective Floor Cavity Reflectance 20%

ZONAL LUMEN SUMMARY

ZONE	LUMENS	%LUMINAIRE
0-30	1,236.5	95.5%
0-40	1,294.2	100%
0-60	1,294.3	100%
60-90	0.0	0%
0-90	1,294.3	100%

MULTIPLE UNIT DATA - (RCR 2)

SPACING ON CENTER	INITIAL FOOTCANDLES	WATTS/ SQ. FT.
5'	65	0.59
6'	36	0.33
7'	25	0.23
8'	25	0.23
9'	16	0.15

38' x 38' x 10' Room. Workplan located 2-1/2' (30").
Reflectance factor 80%/50%/30%

CANDELAS DISTRIBUTION

DEGREES/ VERTICAL	CANDELAS	DEGREES/ VERTICAL	CANDELAS
0	3,940	40	2
5	3,712	50	0
10	3,055	60	0
15	2,111	70	0
20	1,232	80	0
25	644	90	0
30	293		

Ardito LED - A4SFR

4" Series

Ultra-Thin Profile Square Regressed Trim

PHOTOMETRIC DATA



3,000K, 90+ CRI, Flood, Performance 1

CANDLEPOWER DISTRIBUTION

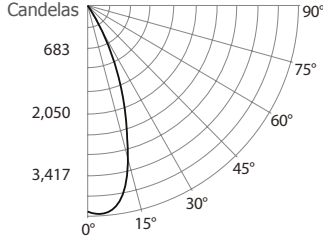

LIGHT CONE

Distance	FC	DIA
06'	74.8	4.3'
08'	42.1	5.7'
10'	26.9	7.1'
12'	18.7	8.5'
14'	13.7	10.0'
16'	10.5	11.4'

Beam: 40°
Beam Edge defined as 50% of Maximum Nadir Candle-power.

LUMINAIRE

Performance 1 LED	3,000K Flood	
CBCP / Lumens	2,692 / 1,257.3	
Watts	120V	277V
	14W	14.5W
Operating AMPS	0.12A	0.052A
Lumen Maintenance	L70 @ 50,000 Hrs	
CRI	90+	
Lumens/Watt	89.9	
Spacing Criteria	0.68	

COEFFICIENT OF UTILIZATION - %

Ceiling Reflect %	80		50		30		
Wall Reflect %	50	30	50	30	50	30	
RCR	0	119	119	111	111	106	106
	2	106	103	101	99	98	96
	4	96	91	93	89	91	88
	6	87	82	85	81	84	80
	8	80	75	78	74	78	74
	10	74	69	73	69	72	68

Zonal Cavity Method
Effective Floor Cavity Reflectance 20%

ZONAL LUMEN SUMMARY

ZONE	LUMENS	%LUMINAIRE
0-30	1,170.6	93.1%
0-40	1,255.4	99.9%
0-60	1,257.3	100%
60-90	0.0	0%
0-90	1,257.3	100%

MULTIPLE UNIT DATA - (RCR 2)

SPACING ON CENTER	INITIAL FOOTCANDLES	WATTS/ SQ. FT.
5'	62	0.58
6'	35	0.33
7'	24	0.23
8'	24	0.23
9'	16	0.15

38' x 38' x 10' Room. Workplan located 2-1/2' (30").
Reflectance factor 80%/50%/30%

CANDELAS DISTRIBUTION

DEGREES/ VERTICAL	CANDELAS	DEGREES/ VERTICAL	CANDELAS
0	2,692	40	11
5	2,715	50	0
10	2,508	60	0
15	1,952	70	0
20	1,329	80	0
25	847	90	0
30	391		

3,000K, 90+ CRI, Spot, Performance 2

CANDLEPOWER DISTRIBUTION

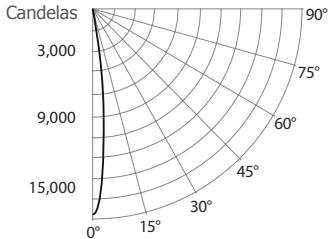

LIGHT CONE

Distance	FC	DIA
06'	478.9	1.5'
08'	269.4	2.1'
10'	172.4	2.6'
12'	119.7	3.1'
14'	87.9	3.6'
16'	67.3	4.1'

Beam: 15°
Beam Edge defined as 50% of Maximum Nadir Candle-power.

LUMINAIRE

Performance 2 LED	3,000K Spot	
CBCP / Lumens	17,240 / 1,923	
Watts	120V	277V
	23W	23.5W
Operating AMPS	0.19A	0.085A
Lumen Maintenance	L70 @ 50,000 Hrs	
CRI	90+	
Lumens/Watt	83.6	
Spacing Criteria	0.26	

COEFFICIENT OF UTILIZATION - %

Ceiling Reflect %	80		50		30		
Wall Reflect %	50	30	50	30	50	30	
RCR	0	121	121	113	113	108	108
	2	110	107	105	103	103	101
	4	103	99	100	97	98	95
	6	96	93	94	91	93	91
	8	91	88	90	87	89	86
	10	87	84	86	83	86	83

Zonal Cavity Method
Effective Floor Cavity Reflectance 20%

ZONAL LUMEN SUMMARY

ZONE	LUMENS	%LUMINAIRE
0-30	1,883.2	97.9%
0-40	1,922.6	100%
0-60	1,923.0	100%
60-90	0.0	0%
0-90	1,923.0	100%

MULTIPLE UNIT DATA - (RCR 2)

SPACING ON CENTER	INITIAL FOOTCANDLES	WATTS/ SQ. FT.
5'	97	1.02
6'	55	0.57
7'	38	0.4
8'	38	0.4
9'	24	0.25

38' x 38' x 10' Room. Workplan located 2-1/2' (30").
Reflectance factor 80%/50%/30%

CANDELAS DISTRIBUTION

DEGREES/ VERTICAL	CANDELAS	DEGREES/ VERTICAL	CANDELAS
0	17,240	40	1
5	12,102	50	0
10	5,541	60	0
15	2,109	70	0
20	1,173	80	0
25	699	90	0
30	278		

Ardito LED - A4SFR

4" Series

Ultra-Thin Profile Square Regressed Trim

PHOTOMETRIC DATA



3,000K, 90+ CRI, Narrow Flood, Performance 2

CANDLEPOWER DISTRIBUTION

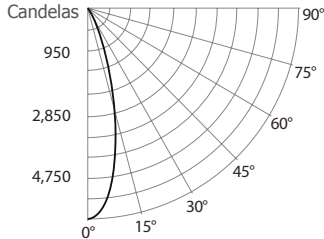

LIGHT CONE

Distance	FC	DIA
06'	158.3	3.4'
08'	89.04	4.6'
10'	56.9	5.7'
12'	39.6	6.9'
14'	29.1	8.0'
16'	22.3	9.2'

Beam: 32°
Beam Edge defined as 50% of Maximum Nadir Candle-power.

LUMINAIRE

Performance 2 LED	3,000K	Narrow Flood
CBCP / Lumens	5,699	/ 1,868.7
Watts	120V	277V
	23W	23.5W
Operating AMPS	0.19A	0.085A
Lumen Maintenance	L70 @ 50,000 Hrs	
CRI	90+	
Lumens/Watt	81.2	
Spacing Criteria	0.55	

COEFFICIENT OF UTILIZATION - %

Ceiling Reflect %	80			50			30		
Wall Reflect %	50	30	50	30	50	30	50	30	
RCR	0	119	119	111	111	106	106	106	
	2	107	104	102	100	99	97	97	
	4	97	93	94	91	93	90	90	
	6	90	85	88	84	86	83	83	
	8	83	79	82	78	81	78	78	
	10	78	73	77	73	76	72	72	

Zonal Cavity Method
Effective Floor Cavity Reflectance 20%

ZONAL LUMEN SUMMARY

ZONE	LUMENS	%LUMINAIRE
0-30	1,785.1	95.5%
0-40	1,868.5	100%
0-60	1,868.7	100%
60-90	0.0	0%
0-90	1,868.7	100%

MULTIPLE UNIT DATA - (RCR 2)

SPACING ON CENTER	INITIAL FOOTCANDLES	WATTS/ SQ. FT.
5'	93	1.01
6'	52	0.57
7'	36	0.39
8'	36	0.39
9'	23	0.25

38' x 38' x 10' Room. Workplan located 2-1/2' (30").
Reflectance factor 80%/50%/30%

CANDELAS DISTRIBUTION

DEGREES/ VERTICAL	CANDELAS	DEGREES/ VERTICAL	CANDELAS
0	5,699	40	2
5	5,377	50	0
10	4,410	60	0
15	3,039	70	0
20	1,777	80	0
25	931	90	0
30	407		

3,000K, 90+ CRI, Flood, Performance 2

CANDLEPOWER DISTRIBUTION

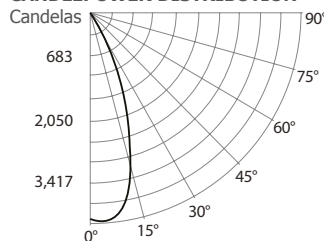

LIGHT CONE

Distance	FC	DIA
06'	111.5	4.2'
08'	62.7	5.7'
10'	40.1	7.1'
12'	27.9	8.5'
14'	20.5	9.9'
16'	15.7	11.3'

Beam: 40°
Beam Edge defined as 50% of Maximum Nadir Candle-power.

LUMINAIRE

Performance 2 LED	3,000K	Flood
CBCP / Lumens	4,012	/ 1,878.2
Watts	120V	277V
	23W	23.5W
Operating AMPS	0.19A	0.085A
Lumen Maintenance	L70 @ 50,000 Hrs	
CRI	90+	
Lumens/Watt	81.7	
Spacing Criteria	0.98	

COEFFICIENT OF UTILIZATION - %

Ceiling Reflect %	80			50			30		
Wall Reflect %	50	30	50	30	50	30	50	30	
RCR	0	119	119	111	111	106	106	106	
	2	106	103	101	99	98	96	96	
	4	96	91	93	89	91	88	88	
	6	87	82	85	81	84	80	80	
	8	80	75	78	74	78	74	74	
	10	74	69	73	69	72	68	68	

Zonal Cavity Method
Effective Floor Cavity Reflectance 20%

ZONAL LUMEN SUMMARY

ZONE	LUMENS	%LUMINAIRE
0-30	1,747.1	93%
0-40	1,875.4	99.8%
0-60	1,878.2	100%
60-90	0.0	0%
0-90	1,878.2	100%

MULTIPLE UNIT DATA - (RCR 2)

SPACING ON CENTER	INITIAL FOOTCANDLES	WATTS/ SQ. FT.
5'	93	1.01
6'	52	0.57
7'	36	0.39
8'	36	0.39
9'	23	0.25

38' x 38' x 10' Room. Workplan located 2-1/2' (30").
Reflectance factor 80%/50%/30%

CANDELAS DISTRIBUTION

DEGREES/ VERTICAL	CANDELAS	DEGREES/ VERTICAL	CANDELAS
0	4,012	40	19
5	4,053	50	0
10	3,761	60	0
15	2,915	70	0
20	1,974	80	0
25	1,268	90	0
30	582		