

Concerto LED - LD2K

4" Series

Project	
Notes	
Fixture Type	
Date	

Low Profile Square Regressed Trim



LD2KC-12BRBK
(illustrated)

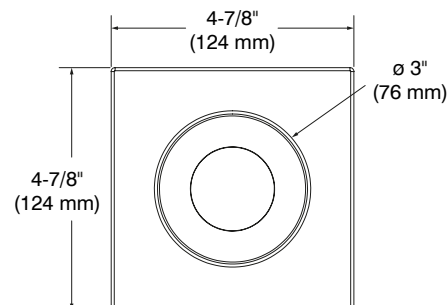
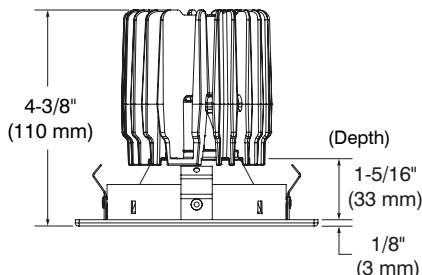

DESCRIPTION

This series of fixed round or square trims offered with narrow flood or flood beam will be highly appreciated in the following applications: highlight of various objects in shows and museums or for certain tasks such as above a work table, for kids homework, kitchen island, sewing, etc ...

SPECIFICATIONS

COLOR TEMPERATURE	2,700K, 3,000K, 3,500K and 4,000K
CRI	80 + 90 + (only at 3,000K)
POWER SUPPLY	Several driver models available giving you 2 dimming options: ELV and 0-10V. Refer to the housing specifications sheet for more details.
LED MODULE	Bridgelux Vero 18, delivers a lumen maintenance greater than 70% after 50,000 hours of operation (L_{70}). Provides a high quality true color and a clean white light without hot spots. Binning within 3 steps on MacAdam ellipse. CREE CXA2530 delivers a lumen maintenance greater than 70% after 50,000 hours of operation (L_{70}). Provides a high quality true color and a clean white light without hot spots. Binning within 4 steps on MacAdam ellipse. Both modules surpass ANSI binning requirements.
DELIVERED LUMENS (Determined by the choice of housing)	Performance 1: 1,060 lumens, 66 lm/W Performance 2: 1,370 lumens, 63 lm/W Performance 3: 1,850 lumens, 63 lm/W
TRIM	Powder coated paint or plated die-formed steel. Different finishes available.
OPTIC SYSTEM	Interchangeable optional optical reflectors and lenses available to personalize your lighting. Protection lens covered with a high-performance film 98% effective. Lens of 1/8" (3 mm) thick and 1.9" (47 mm) Ø. Choice of available lenses: Clear (C), Frosted (F), Honeycombs (H), Linear (L), Prismatic (P) and Solite (S) Optical reflectors available: M: Narrow Flood → 33° W: Flood → 48°



Concerto LED - LD2K

4" Series

SPECIFICATIONS (CONT'D)

HEAT SINK High quality aluminum injected heat sink ensuring maximum heat dissipation.

REFLECTORS	Anodized	Specular	Painted
	Anodized Aluminum (AN)	Clear (CL) Black (BK)	White (01)* Black (02) Architectural Bronze (05)* Antique Copper (06)* Matte White (11)* Metallic Grey (15)*

*These reflector colors are available only with the same trim color.

CEILING CUTOUT \varnothing 4-1/4" (108 mm)

COMPATIBLE HOUSINGS

(Performance 2 trims work with either performance 1 and 2 housings.)

(Performance 3 trims works only with performance 3 housings.)

	Remodel Housing	New Construction Housing	Insulated Housing
Performance 1 (1,500 lumens)	RELD200LD1 RELD200LV1	NWLD200LD1 NWLD200LV1	ISLD200LD1 ISLD200LV1
Performance 2 (2,000 lumens)	RELD200LD2 RELD200LV2	NWLD200LD2 NWLD200LV2	ISLD200LD2 ISLD200LV2
Performance 3 (2,500 lumens)	Not Available	NWLD200LD3	Not Available

For dimming, please refer to the selected housing specification sheet.

CERTIFICATION cULus **E343977** for **damp locations**

WARRANTY 1 year for standard finishes and 5 years on LED module.



CONTRASTE

2019-10
Revision 3

PRINTED IN CANADA

1009, rue du Parc Industriel
Lévis (Québec) G6Z 1C5 Canada
Tel.: 1-888-839-4624
Fax.: 1-877-839-7057
contrastelighting.com
info@contrastelighting.com

© 2019 Contraste Lighting M.L. Inc.
All rights reserved

Contrast Lighting M.L. Inc. reserves the right to make changes in specifications and/or to discontinue any product at any time without notice or obligation and will not be liable for any consequences resulting from the use of this publication.

Concerto LED - LD2K

4" Series

PHOTOMETRIC DATA

3,000K, 80 + of CRI, Narrow Flood with performance 1 housing

CANDLEPOWER DISTRIBUTION

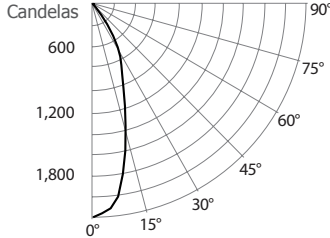

LIGHT CONE

Distance	FC	DIA
06'	59.0	3.8'
08'	33.2	5.1'
10'	21.2	6.3'
12'	14.7	7.6'
14'	10.8	8.9'
16'	8.3	10.1'

Beam: 35°
Beam Edge defined as 50% of Maximum Nadir Candle-power.

LUMINAIRE

Performance 1 LED	3,000K	Narrow Flood
CBCP / Lumens	2,123	/ 1,040
Watts	120V	277V
	15.9W	16.4W
Operating AMPS	0.13A	0.059A
Lumen Maintenance	L70 @ 50,000 Hrs	
CRI	80 +	
Lumens/Watt	65	
Spacing Criteria	0.6	
Certificate LM79-08	Based on test 475903	

COEFFICIENT OF UTILIZATION - %

Ceiling Reflect %	80	50	30				
Wall Reflect %	50	30	50	30	50	30	
RCR	0	119	119	111	111	106	106
	2	107	104	102	100	99	97
	4	98	94	95	91	93	90
	6	90	86	88	84	87	84
	8	83	79	82	78	81	77
	10	77	72	76	72	75	71

Zonal Cavity Method

Effective Floor Cavity Reflectance 20%

ZONAL LUMEN SUMMARY

ZONE	LUMENS	%LUMINAIRE
0-30	846	81.34%
0-40	1,002	96.41%
0-60	1,025	98.56%
60-90	15	1.44%
0-90	1,040	100%

MULTIPLE UNIT DATA - (RCR 2)

SPACING ON CENTER	INITIAL FOOTCANDLES	WATTS/SQ. FT.
5'	51	0.71
6'	28	0.4
7'	20	0.28
8'	20	0.28
9'	13	0.18

Local 38' x 38' x 10'. Workplan located 2 1/2' (30°).
Reflection factor of 80%/50%/30%.

CANDELAS DISTRIBUTION

DEGREES/VERTICAL	CANDELAS	DEGREES/VERTICAL	CANDELAS
0	2,123	45	14
5	2,044	55	8
10	1,723	65	5
15	1,265	75	6
20	894	85	6
25	672	90	0
35	250		

3,000K, 80 + of CRI, Flood with performance 1 housing

CANDLEPOWER DISTRIBUTION

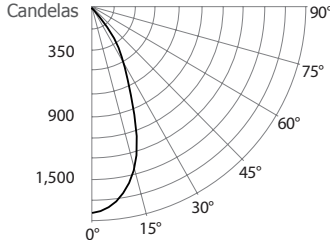

LIGHT CONE

Distance	FC	DIA
06'	47.8	5.1'
08'	26.9	6.8'
10'	17.2	8.5'
12'	12.0	10.2'
14'	8.8	11.9'
16'	6.7	13.5'

Beam: 46°
Beam Edge defined as 50% of Maximum Nadir Candle-power.

LUMINAIRE

Performance 1 LED	3,000K	Flood
CBCP / Lumens	1,722	/ 1,056
Watts	120V	277V
	16.1W	16.6W
Operating AMPS	0.19A	0.059A
Lumen Maintenance	L70 @ 50,000 Hrs	
CRI	80 +	
Lumens/Watt	66	
Spacing Criteria	0.7	
Certificate LM79-08	Based on test 475906	

COEFFICIENT OF UTILIZATION - %

Ceiling Reflect %	80	50	30				
Wall Reflect %	50	30	50	30	50	30	
RCR	0	119	119	111	111	106	106
	2	104	100	99	96	96	94
	4	92	87	89	85	87	83
	6	82	77	80	76	79	75
	8	74	69	73	68	72	68
	10	68	62	66	62	66	61

Zonal Cavity Method

Effective Floor Cavity Reflectance 20%

ZONAL LUMEN SUMMARY

ZONE	LUMENS	%LUMINAIRE
0-30	859	81.3%
0-40	1,018	96.3%
0-60	1,042	98.5%
60-90	15	1.5%
0-90	1,056	100%

MULTIPLE UNIT DATA - (RCR 2)

SPACING ON CENTER	INITIAL FOOTCANDLES	WATTS/SQ. FT.
5'	51	0.71
6'	29	0.4
7'	20	0.28
8'	20	0.28
9'	13	0.18

Local 38' x 38' x 10'. Workplan located 2 1/2' (30°).
Reflection factor of 80%/50%/30%.

CANDELAS DISTRIBUTION

DEGREES/VERTICAL	CANDELAS	DEGREES/VERTICAL	CANDELAS
0	1,722	45	16
5	1,683	55	8
10	1,544	65	5
15	1,326	75	6
20	1,055	85	6
25	726	90	0
35	254		

Concerto LED - LD2K

4" Series

PHOTOMETRIC DATA

3,000K, 80 + of CRI, Narrow Flood with performance 2 housing

CANDLEPOWER DISTRIBUTION

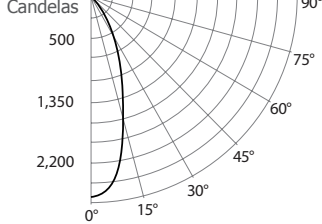

LIGHT CONE

Distance	FC	DIA
06'	72.4	3.8'
08'	40.7	5.1'
10'	26.1	6.4'
12'	18.1	7.7'
14'	13.3	9.0'
16'	10.2	10.2'

Beam: 35°
Beam Edge defined as 50% of Maximum Nadir Candle-power.

LUMINAIRE

Performance 2 LED	3,000K	Narrow Flood
CBCP / Lumens	2,607	/ 1,278
Watts	120V	277V
	21.5W	22W
Operating AMPS	0.18A	0.079A
Lumen Maintenance	L70 @ 50,000 Hrs	
CRI	80 +	
Lumens/Watt	59	
Spacing Criteria	0.6	
Certificate LM79-08	Based on test 475903	

COEFFICIENT OF UTILIZATION - %

Ceiling Reflect %	80			50			30		
Wall Reflect %	50	30	50	30	50	30	50	30	50
RCR	0	119	119	111	111	106	106	106	106
	2	104	101	99	97	96	94	94	94
	4	93	88	89	85	88	84	84	84
	6	83	78	81	77	80	76	76	76
	8	75	70	74	69	73	69	69	69
	10	69	64	68	63	67	63	63	63

Zonal Cavity Method
Effective Floor Cavity Reflectance 20%

ZONAL LUMEN SUMMARY

ZONE	LUMENS	%LUMINAIRE
0-30	1,039	81.3%
0-40	1,232	96.4%
0-60	1,260	98.6%
60-90	18	1.4%
0-90	1,278	100%

MULTIPLE UNIT DATA - (RCR 2)

SPACING ON CENTER	INITIAL FOOTCANDLES	WATTS/SQ. FT.
5'	62	0.71
6'	35	0.4
7'	24	0.28
8'	24	0.28
9'	16	0.18

Local 38' x 38' x 10'. Workplan located 2 1/2' (30°).
Reflection factor of 80%/50%/30%.

CANDELAS DISTRIBUTION

DEGREES/VERTICAL	CANDELAS	DEGREES/VERTICAL	CANDELAS
0	2,607	45	18
5	2,510	55	9
10	2,116	65	6
15	1,554	75	8
20	1,097	85	7
25	825	90	0
35	307		

3,000K, 80 + of CRI, Flood with performance 2 housing

CANDLEPOWER DISTRIBUTION

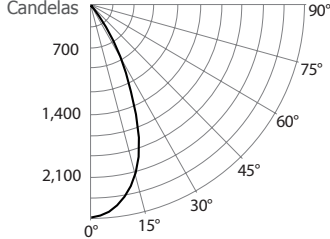

LIGHT CONE

Distance	FC	DIA
06'	60.8	5.3'
08'	34.2	7.1'
10'	21.9	8.8'
12'	15.2	10.6'
14'	11.2	12.4'
16'	8.5	14.1'

Beam: 48°
Beam Edge defined as 50% of Maximum Nadir Candle-power.

LUMINAIRE

Performance 2 LED	3,000K	Flood
CBCP / Lumens	2,187	/ 1,370
Watts	120V	277V
	21.5W	22W
Operating AMPS	0.18A	0.079A
Lumen Maintenance	L70 @ 50,000 Hrs	
CRI	80 +	
Lumens/Watt	63.4	
Spacing Criteria	0.7	
Certificate LM79-08	Based on test 475915	

COEFFICIENT OF UTILIZATION - %

Ceiling Reflect %	80			50			30		
Wall Reflect %	50	30	50	30	50	30	50	30	50
RCR	0	119	119	111	111	106	106	106	106
	2	107	104	102	100	99	97	97	97
	4	98	94	95	92	93	90	90	90
	6	90	86	88	85	87	84	84	84
	8	83	79	82	78	81	78	78	78
	10	77	73	76	72	76	72	72	72

Zonal Cavity Method
Effective Floor Cavity Reflectance 20%

ZONAL LUMEN SUMMARY

ZONE	LUMENS	%LUMINAIRE
0-30	1,144	83.52%
0-40	1,322	96.51%
0-60	1,348	98.40%
60-90	22	1.60%
0-90	1,370	100%

MULTIPLE UNIT DATA - (RCR 2)

SPACING ON CENTER	INITIAL FOOTCANDLES	WATTS/SQ. FT.
5'	67	0.96
6'	37	0.54
7'	26	0.37
8'	26	0.37
9'	17	0.24

Local 38' x 38' x 10'. Workplan located 2 1/2' (30°).
Reflection factor of 80%/50%/30%.

CANDELAS DISTRIBUTION

DEGREES/VERTICAL	CANDELAS	DEGREES/VERTICAL	CANDELAS
0	2,187	45	17
5	2,138	55	10
10	2,006	65	6
15	1,790	75	9
20	1,453	85	7
25	982	90	0
35	274		



Concerto LED - LD2K

4" Series

PHOTOMETRIC DATA

3,000K, 80 + of CRI, Narrow Flood with performance 3 housing

CANDLEPOWER DISTRIBUTION

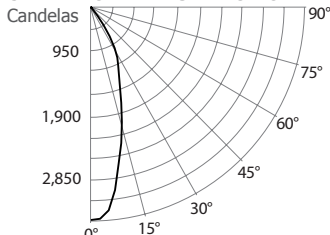

LIGHT CONE

Distance	FC	DIA
06'	94.7	3.6'
08'	53.3	4.8'
10'	34.1	6.0'
12'	23.7	7.2'
14'	17.4	8.4'
16'	13.3	9.6'

Beam: 33°
Beam Edge defined as 50% of Maximum Nadir Candle-power.

LUMINAIRE

Performance 3 LED	3,000K	Narrow Flood
CBCP / Lumens	3,409	/ 1,566
Watts	120V	277V
	29.2W	29.7W
Operating AMPS	0.24A	0.107A
Lumen Maintenance	L70 @ 50,000 Hrs	
CRI	80 +	
Lumens/Watt	53.6	
Spacing Criteria	0.5	
Certificate LM79-08	Based on test 607002	

COEFFICIENT OF UTILIZATION - %

Ceiling Reflect %	80			50			30		
Wall Reflect %	50	30	50	30	50	30	50	30	
RCR	0	119	119	111	111	106	106	106	
	2	107	104	102	100	99	98	98	
	4	98	94	95	92	93	90	90	
	6	91	86	88	85	87	84	84	
	8	84	79	82	78	81	78	78	
	10	77	73	76	72	76	72	72	

Zonal Cavity Method

Effective Floor Cavity Reflectance 20%

ZONAL LUMEN SUMMARY

ZONE	LUMENS	%LUMINAIRE
0-30	1,287	82.22%
0-40	1,512	96.58%
0-60	1,544	98.62%
60-90	22	1.38%
0-90	1,566	100%

MULTIPLE UNIT DATA - (RCR 2)

SPACING ON CENTER	INITIAL FOOTCANDLES	WATTS/SQ. FT.
5'	76	1.29
6'	43	0.73
7'	30	0.51
8'	30	0.51
9'	19	0.32

Local 38' x 38' x 10'. Workplan located 2 1/2' (30°).
Reflection factor of 80%/50%/30%.

CANDELAS DISTRIBUTION

DEGREES/VERTICAL	CANDELAS	DEGREES/VERTICAL	CANDELAS
0	3,409	45	22
5	3,272	55	11
10	2,549	65	8
15	1,912	75	9
20	1,352	85	8
25	1,030	90	0
35	355		

3,000K, 80 + of CRI, Flood with performance 3 housing

CANDLEPOWER DISTRIBUTION

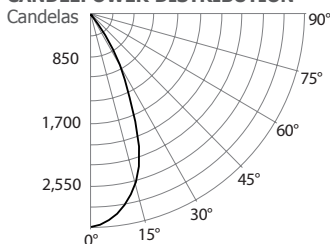

LIGHT CONE

Distance	FC	DIA
06'	83.8	5.2'
08'	47.1	7.0'
10'	30.2	8.7'
12'	20.9	10.4'
14'	15.4	12.2'
16'	11.8	13.9'

Beam: 47°
Beam Edge defined as 50% of Maximum Nadir Candle-power.

LUMINAIRE

Performance 3 LED	3,000K	Flood
CBCP / Lumens	3,016	/ 1,842
Watts	120V	277V
	29,28W	29,78W
Operating AMPS	0,25A	0,107A
Lumen Maintenance	L70 @ 50,000 Hrs	
CRI	80 +	
Lumens/Watt	62,9	
Spacing Criteria	0,7	
Certificate LM79-08	Based on test 607004	

COEFFICIENT OF UTILIZATION - %

Ceiling Reflect %	80			50			30		
Wall Reflect %	50	30	50	30	50	30	50	30	
RCR	0	119	119	111	111	106	106	106	
	2	107	104	102	100	99	98	98	
	4	98	94	95	92	94	91	91	
	6	91	87	89	86	88	85	85	
	8	84	80	83	79	82	78	78	
	10	78	74	77	73	76	73	73	

Zonal Cavity Method

Effective Floor Cavity Reflectance 20%

ZONAL LUMEN SUMMARY

ZONE	LUMENS	%LUMINAIRE
0-30	1,558	84.61%
0-40	1,792	97.31%
0-60	1,821	98.88%
60-90	21	1.12%
0-90	1,842	100%

MULTIPLE UNIT DATA - (RCR 2)

SPACING ON CENTER	INITIAL FOOTCANDLES	WATTS/SQ. FT.
5'	90	1.3
6'	50	0.73
7'	35	0.51
8'	35	0.51
9'	22	0.32

Local 38' x 38' x 10'. Workplan located 2 1/2' (30°).
Reflection factor of 80%/50%/30%.

CANDELAS DISTRIBUTION

DEGREES/VERTICAL	CANDELAS	DEGREES/VERTICAL	CANDELAS
0	3,016	45	20
5	2,933	55	11
10	2,749	65	7
15	2,464	75	8
20	1,996	85	8
25	1,300	90	0
35	361		



Concerto LED - LD2K

4" Series

LD2K MODEL PHOTOMETRIC DATA

With performance 1 housing

	Narrow Flood		Flood	
	Lms	lm/W	Lms	lm/W
2,700K with 80 CRI	985.9	61.4	966	61.5
3,000K with 90 CRI	832	53	745	46.3
3,500K with 80 CRI	1,102	70.2	1,141	72.6
4,000K with 80 CRI	1,123	71.5	1,139	70.3

With performance 2 housing

	Narrow Flood		Flood	
	Lms	lm/W	Lms	lm/W
2,700K with 80 CRI	1,284	59.7	1,260	58.6
3,000K with 90 CRI	947	41.2	1,097	49.6
3,500K with 80 CRI	1,359	62.9	1,452	67.5
4,000K with 80 CRI	1,516	66.2	1,480	68.8

With performance 3 housing

	Narrow Flood		Flood	
	Lms	lm/W	Lms	lm/W
2,700K with 80 CRI	1,760	60.7	1,728	58.8
3,000K with 90 CRI	1,183	40.5	1,465	50
3,500K with 80 CRI	1,359	46.9	1,763	60.8
4,000K with 80 CRI	1,517	51.6	1,797	61.1

* All .ies files are available on our Website.



CONTRASTE

2019-10
Revision 3

PRINTED IN CANADA

1009, rue du Parc Industriel
Lévis (Québec) G6Z 1C5 Canada
Tel.: 1-888-839-4624
Fax.: 1-877-839-7057
contrastelighting.com
info@contrastelighting.com

© 2019 Contraste Lighting M.L. Inc.
All rights reserved

Contrast Lighting M.L. Inc. reserves the right to make changes in specifications and/or to discontinue any product at any time without notice or obligation and will not be liable for any consequences resulting from the use of this publication.

Concerto LED - LD2K

4" Series

CODIFICATION EXAMPLE

LD2KC-01012780M2

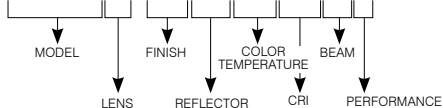

ORDERING CODES

MODEL	LENSES	TRIM FINISHES	REFLECTORS	COLOR TEMPERATURES	CRI	BEAMS	PERFORMANCE
LD2K							
LD2K	C Clear F Frosted H Honeycomb L Linear P Prismatic S Solite	-01 White -02 Black -03 24K Gold Plated -04 Chrome -04BR Brushed Chrome -05 Architectural Bronze -06 Antique Copper -11 Matte White -12BR Brushed Nickel -13 Satin Nickel -15 Metallic Grey	ANODIZED AN Natural Anodized SPECULAR CL Clear BK Black PAINTED 01 White* 02 Black 05 Architectural Bronze* 06 Antique Copper* 11 Matte White* 15 Metallic Grey*	27 2,700K 30 3,000K 35 3,500K 40 4,000K	80 80+ CRI 90 90+ CRI (only with 3,000K)	M Narrow Flood (33°) W Flood(48°)	2 3 Use with Performance 1 or Performance 2 Housings

*These reflector colors are available only with the same trim color.

For future on site modification of the light distribution.

Ordering codes: replacement lenses and reflectors.

Lenses (to modify the light diffusion)

Linear: **103091** Honeycomb: **103089**
 Solite: **103097** Frosted: **313206**
 Prismatic: **103094** Clear: **102958**

Reflectors (to modify the beam angle)

For a Narrow Flood: **316082**
 For a Flood: **316083**

CONTRASTE

2019-10
Revision 3

PRINTED IN CANADA

1009, rue du Parc Industriel
 Lévis (Québec) G6Z 1C5 Canada
 Tel.: 1-888-839-4624
 Fax.: 1-877-839-7057
 contrastelighting.com
 info@contrastelighting.com

© 2019 Contraste Lighting M.L. Inc.
 All rights reserved

Contrast Lighting M.L. Inc. reserves the right to make changes in specifications and/or to discontinue any product at any time without notice or obligation and will not be liable for any consequences resulting from the use of this publication.

