

SPECIFICATION SHEET

RE35GU10-10W

3-1/2" - Classic/Evolution

IC and Air Tight Remodel Housing for GU10 Lamp (LED)

Project _____

Notes _____

Fixture Type _____

Date _____

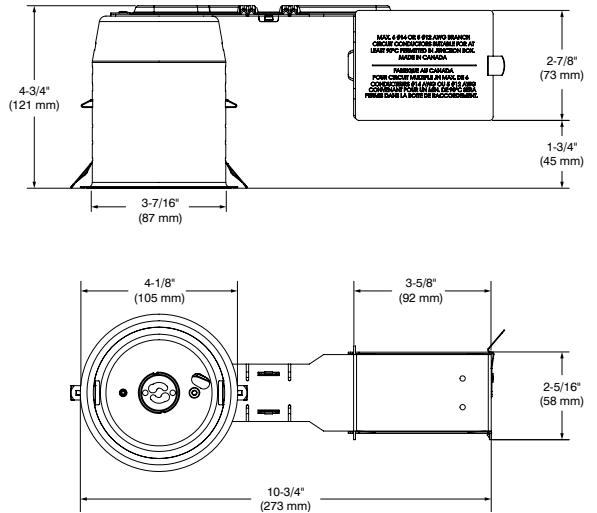
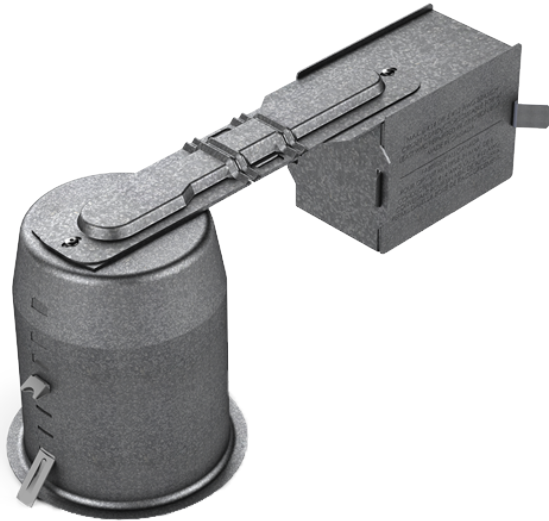

SPECIFICATIONS

HOUSING DETAILS	18 gauge up to 0.051" (1.3 mm) thick galvanized steel housing. Flexible channel wire bracket made of 20 gauge steel, bending up to 45° vertically for ease of installation in confined spaces. 19-1/2 in ³ junction box can support up to 10 - 14 gauge wires or 8 - 12 gauge wires. Below-ceiling accessible.					
MOUNTING AND SUPPORT	Cutout diameter: ø 3-5/8" (92 mm) Can fit ceilings up to 2" (51 mm) thick. Requires a 4-3/4" (121 mm) clearance beyond the ceiling level. Tool-free snap-in hooks for ease of installation and a perfect fit to ceiling. No light leakage.					
LAMPS	GU10 LED 10W MAX					
VOLTAGE	120 Volts					
DIMMING	If you want to use the dimming option, please refer regularly to the lamp manufacturer compatibility list.					
COMPATIBLE TRIMS	R3151	R3652	S3450D	T3145	T3200	T3450W
	R3151W	S3145	T3000	T3145D	T3250	T3850
	R3450D	S3151	T3100	T3145DG	T3450	
	R3470	S3450	T3125	T3145W	T3450D	
CERTIFICATION	<ul style="list-style-type: none"> cULus for damp locations; wet locations for shower trims only Certified Air Tight ASTM E283 					
WARRANTY	1-year limited warranty on components					

CONTRASTE

RE35GU10-10W

3-1/2" - Classic/Evolution

IC and Air Tight Remodel Housing for GU10 Lamp (LED)



CODIFICATION EXAMPLE

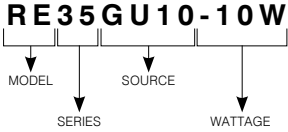

ORDERING CODES

MODEL	SERIES	SOURCE	WATTAGE
RE	35	GU10	-10W
RE Remodel Housing	35 3-1/2" Series	GU10 GU10 LED	-10W 10W

MOUNTING PLATES

Ceiling cutout: \varnothing 3-5/8" (92 mm)

Code: P2550/3600
(Mounting Bars required)

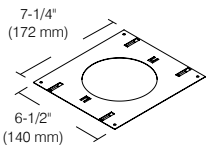

Code: P2550L
(Mounting Bars required)

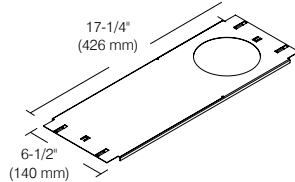

Code: P2550N/3600N
(Mounting Bars NOT required)

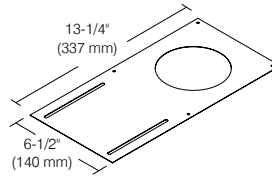

Code: P2550NW
(Mounting Bars INCLUDED)

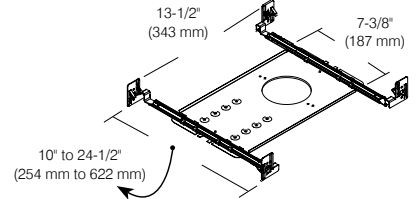

MOUNTING BARS

Short Bars Adjustable (2 units)
From 13-1/2" (343 mm) to 21-3/4" (553 mm)



Long Bars Adjustable (2 units)
From 19-1/2" (495 mm) to 34" (863 mm)

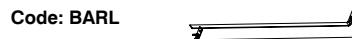

Interlocking Adjustable Bars (2 pairs)
From 10" (254 mm) to 24-1/2" (622 mm)



RE35GU10-10W

3-1/2" - Classic/Evolution

IC and Air Tight Remodel Housing for GU10 Lamp (LED)



GOOF RINGS

Goof rings correct the openings too large or damaged ceiling cutout.

All goof rings are available in all Contraste finishes.
Add finish color code at the end of the goof rings code.
Ex.: RON3000-06

For round trims
Code: RON3000



Outside diameter: \varnothing 6-1/8" (156 mm)
Inside diameter: \varnothing 3-5/8" (92 mm)

For square trims
Code: RON3100



Outside dimensions: 5" (127 mm) x 5" (127 mm)
Inside diameter: \varnothing 3-5/8" (92 mm)

CONTRASTE